

Flexy Compact Cashier Unit with wheels and two stainless steel tray sliders, H=900mm

ITEM # _____

MODEL # _____

NAME # _____

SIS # _____

AIA # _____

322073 (F30N0AW00S)

 Cashier Unit with wheels and
two stainless steel tray
sliders, H=900mm

Short Form Specification

Item No. _____

Compact design, ideal for space saving environments. AISI 304 Foldable tray sliders on long sides. Unit mounted on 125 mm wheels 2 swivel and 2 with brakes. Sturdy body construction with laminated panelings on 4 sides. 900mm worktop height. Unit has protective panelling and is designed to accommodate a cash-register with enough room for the operator's chair. Supplied as standard with a drawer with a lock and key. Available in left or right configuration.

Main Features

- Perfect compact design makes it ideal for space saving environments.
- CB and CE certified by a third party notified body.
- Available options with online configurator: colors, tray sliders, overshelves, feet/wheels with desired diameter, height 750mm for kids.
- Optional plinth can be installed to cover the feet or the wheels.
- Unit has protective panelling and is designed to accommodate a cash-register with enough room for the operator's chair.
- Supplied as standard with a drawer with a lock and key.
- Available in left or right configuration.
- AISI 304 Tray slider in flush mounted stainless steel is installed on long sides and they can also be folded down to facilitate passage of the units through doorways.
- Unit mounted on 125 mm wheels 2 swivel and 2 with brakes.
- Food introduced at the correct temperature maintains its core temperature according to Afnor Standards.

Construction

- Top in AISI 304.
- Sturdy construction with laminated panelings on 4 sides.

APPROVAL: _____

Front

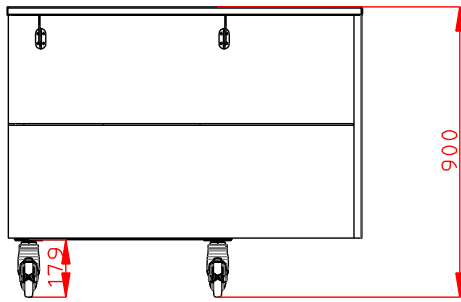

Side

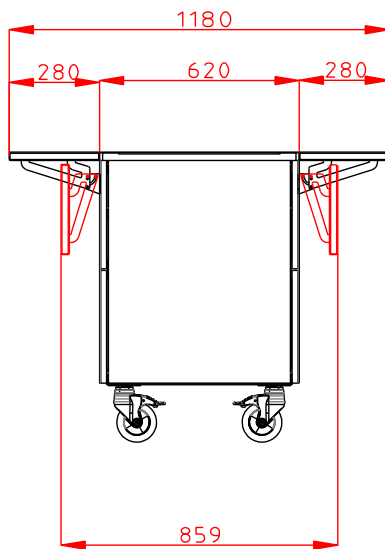

Top

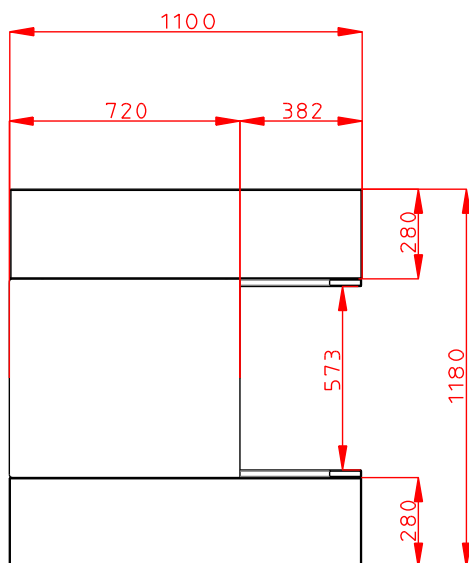
Key Information:

N° of doors:	
External dimensions, Width:	1100 mm
External dimensions, Depth:	1180 mm
External dimensions, Height:	900 mm
Net weight:	83 kg
Shipping height:	1100 mm
Shipping width:	920 mm
Shipping depth:	1230 mm
Shipping volume:	1.24 m ³